

# Hunter®

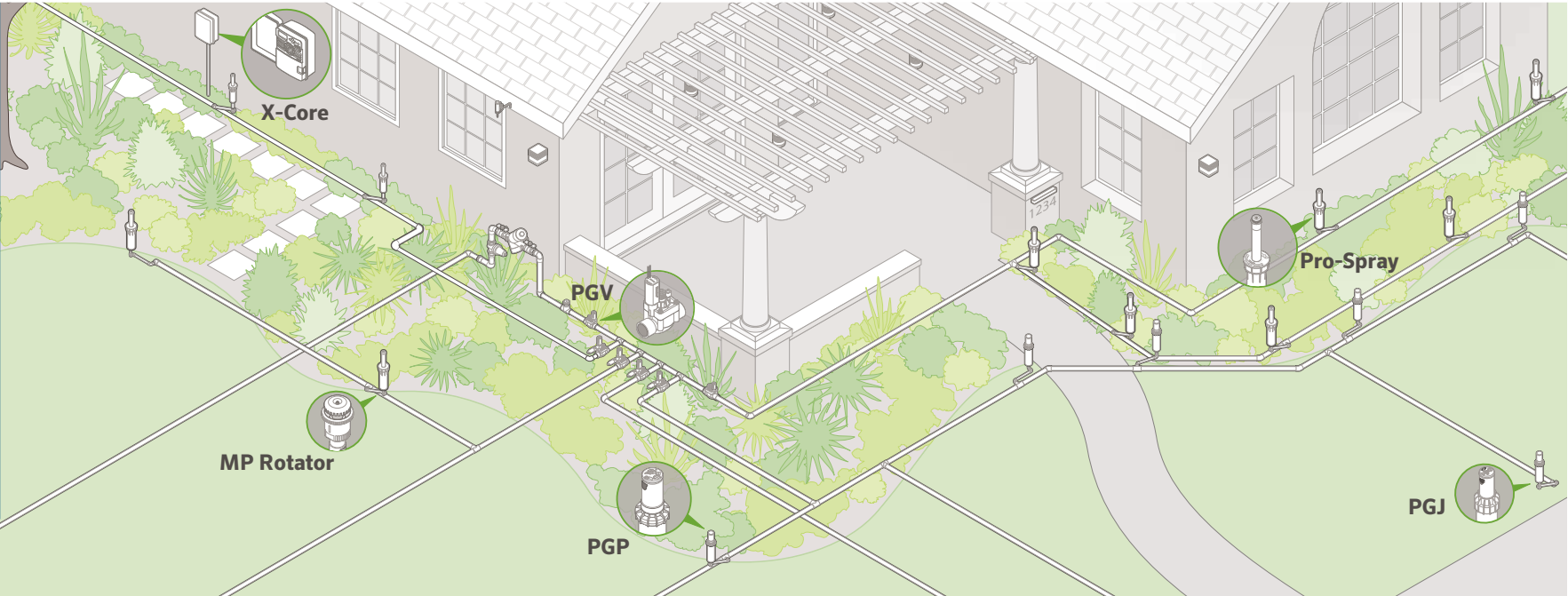

# X-CORE

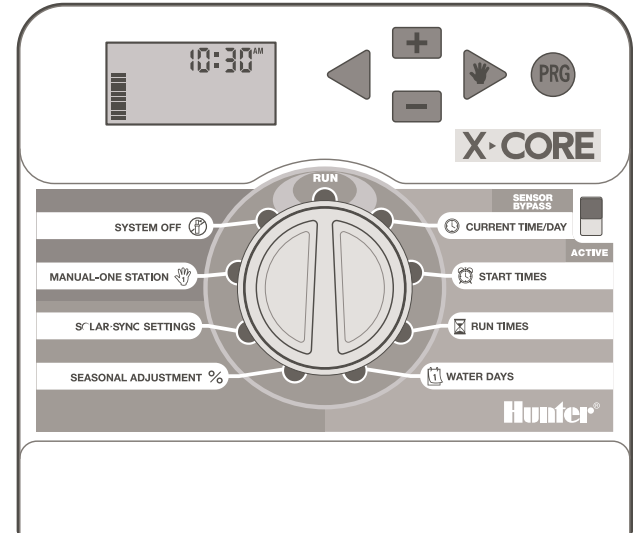

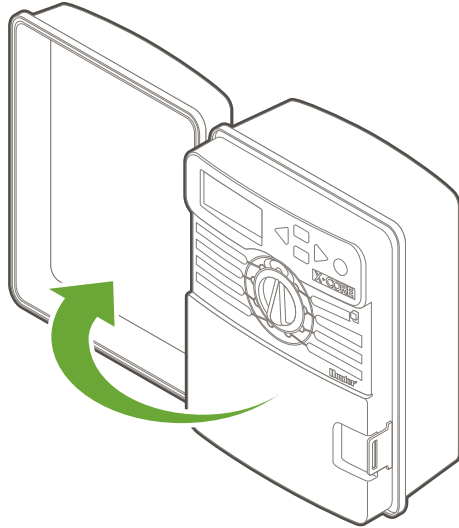
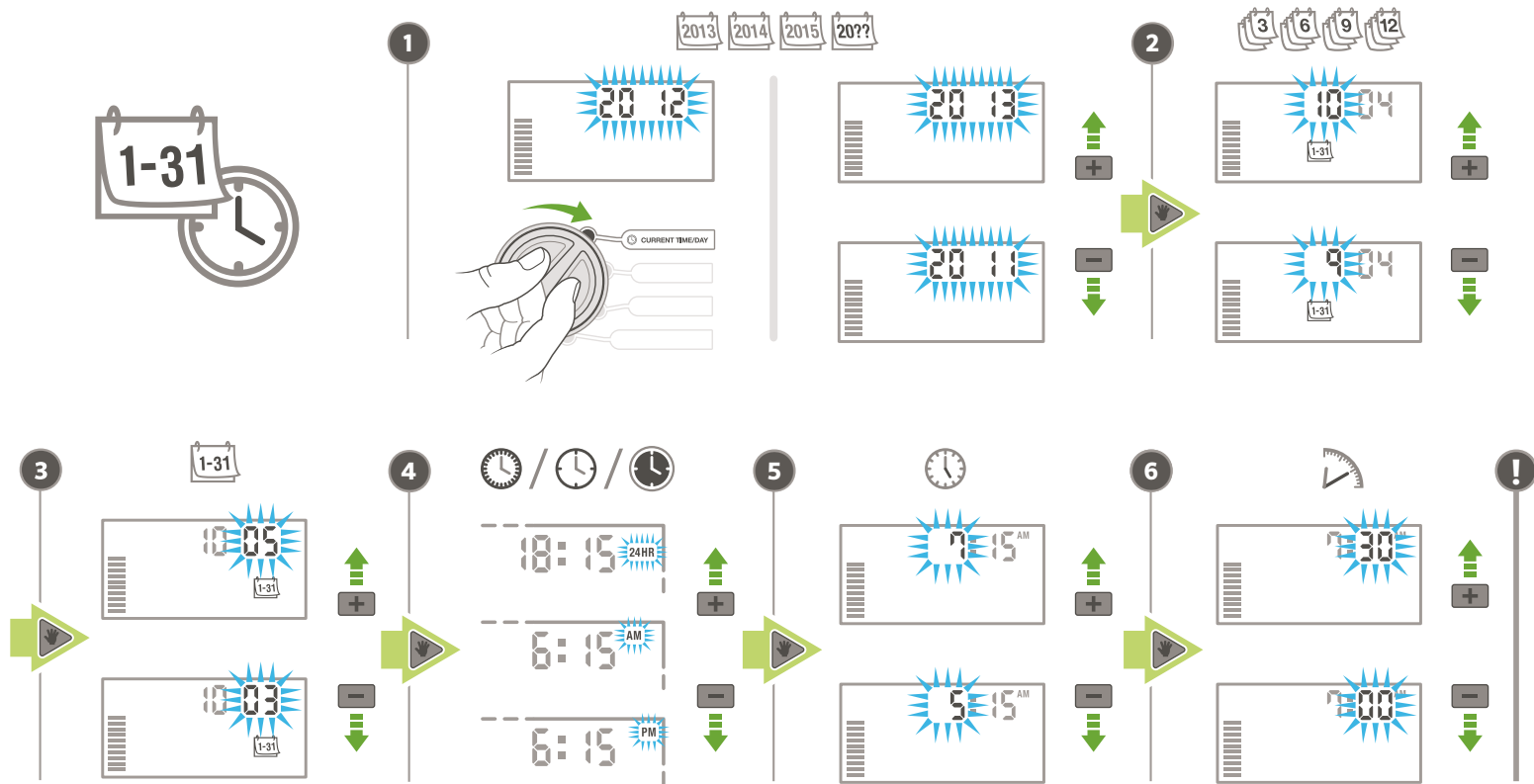

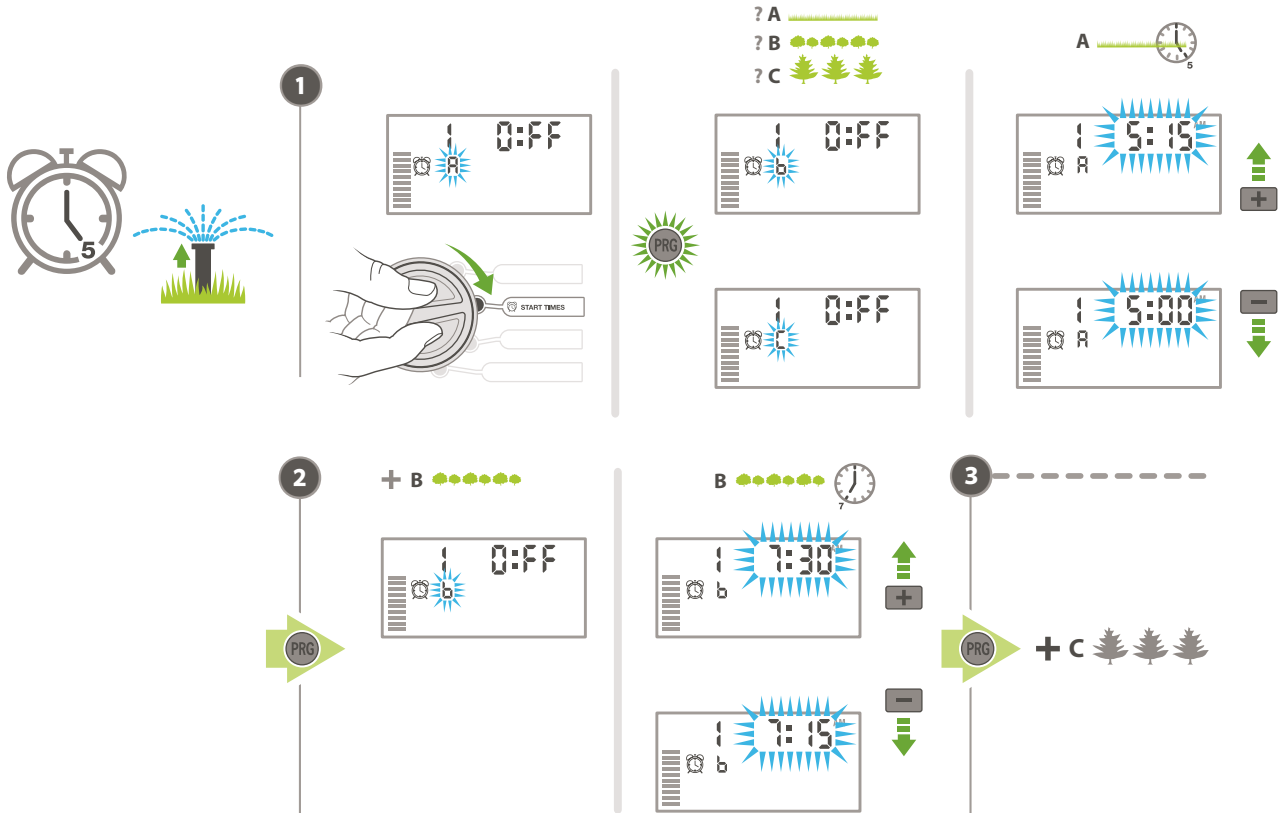

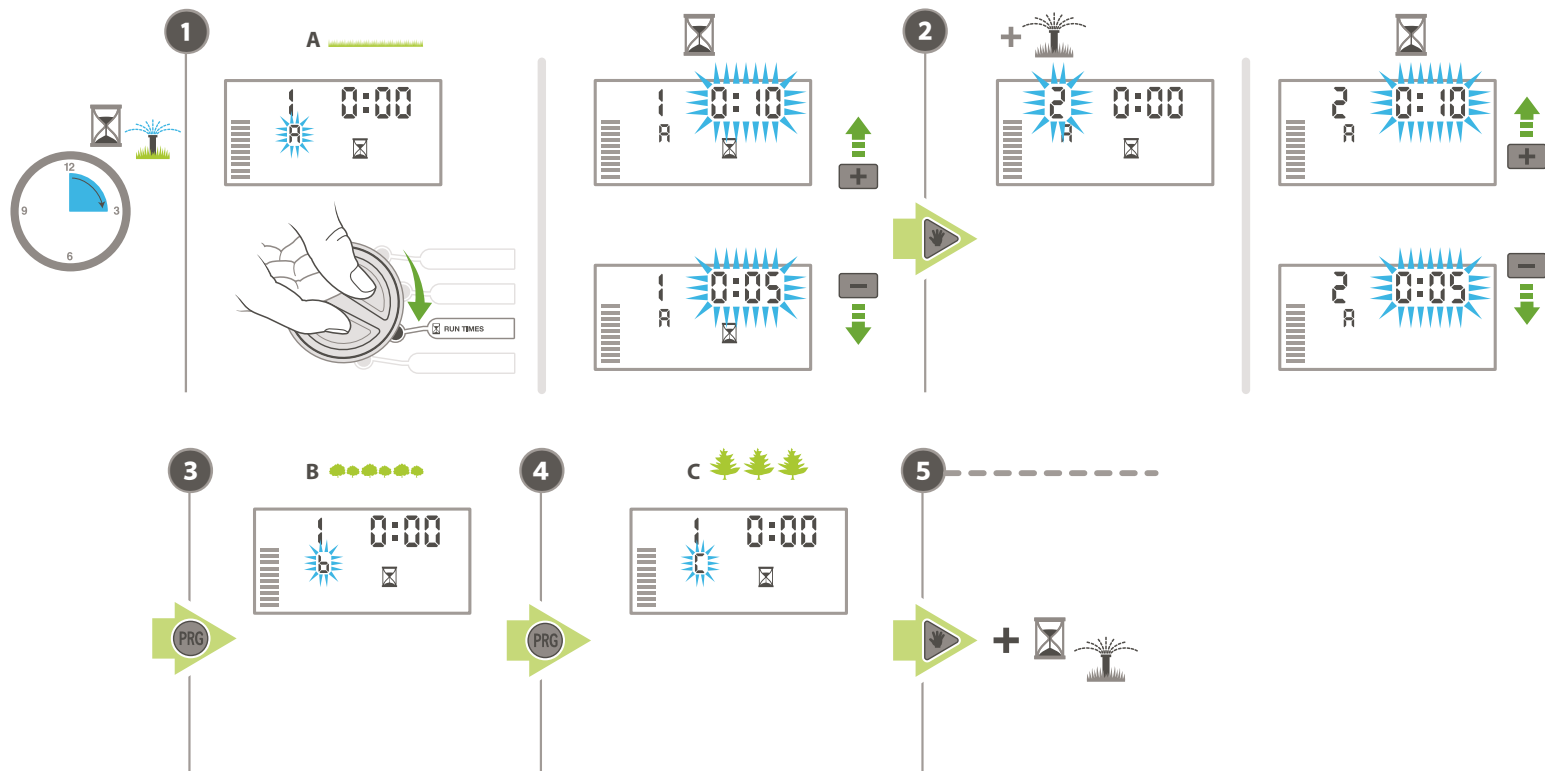



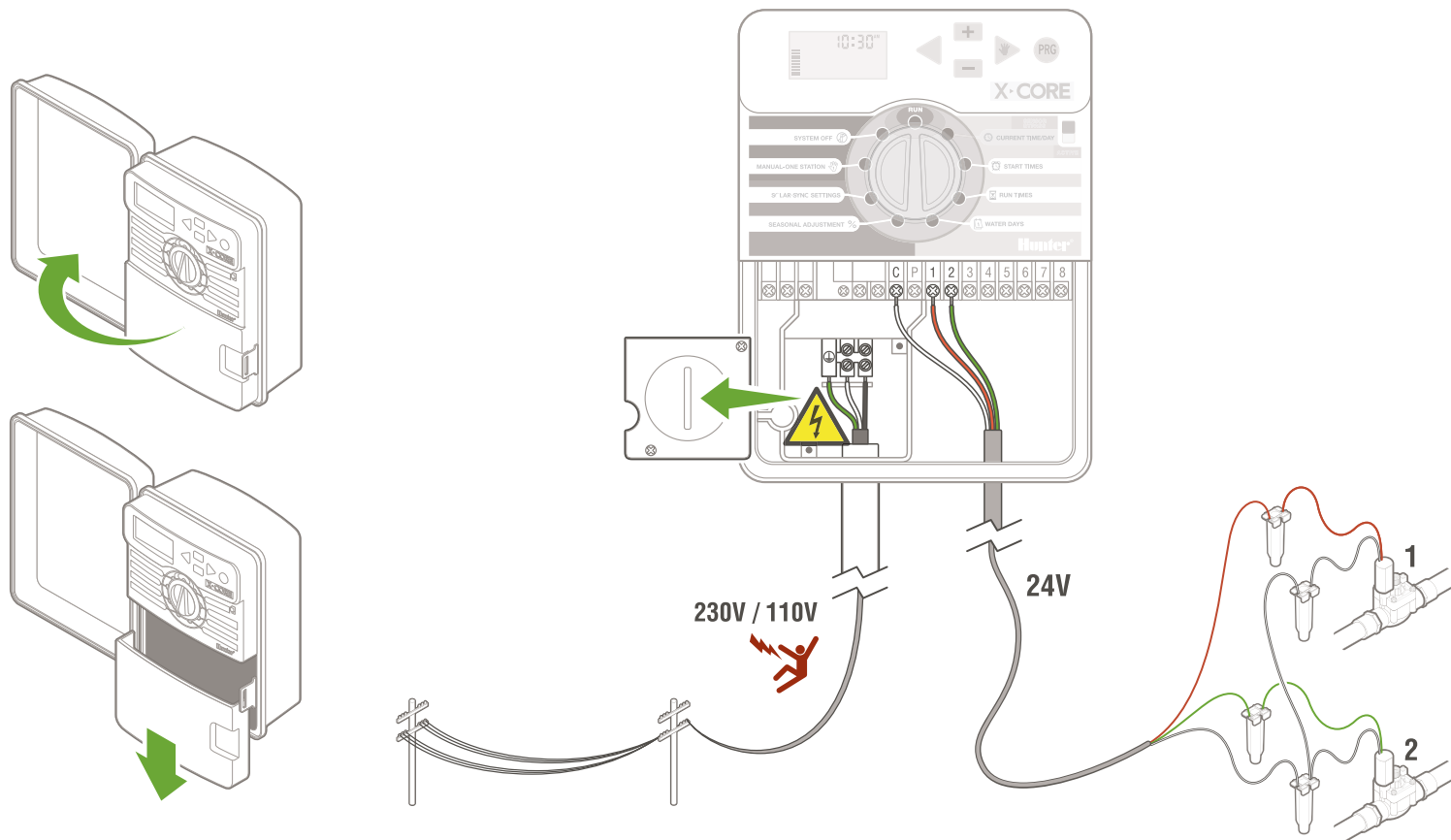

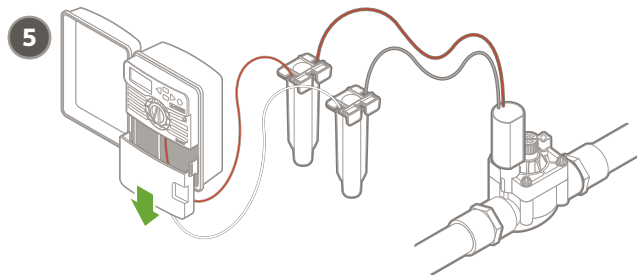
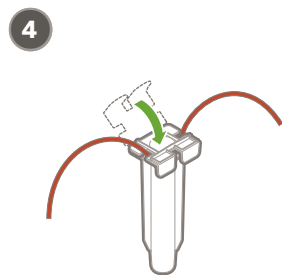
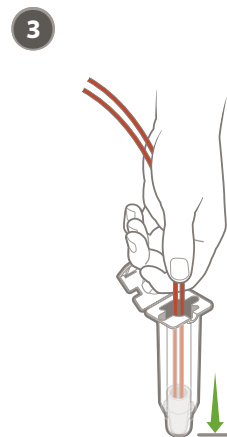
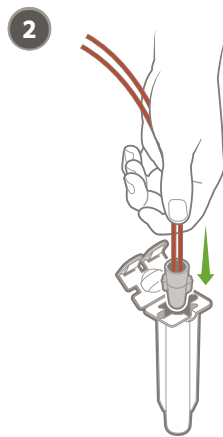
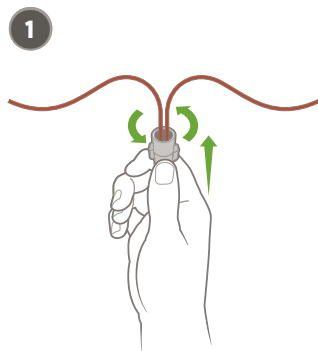



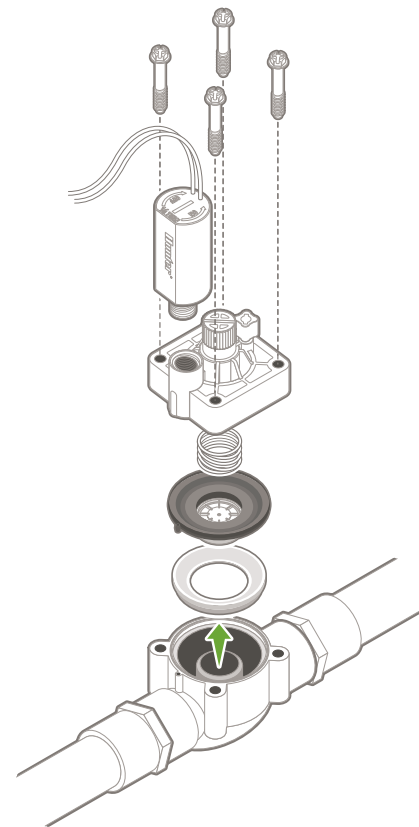
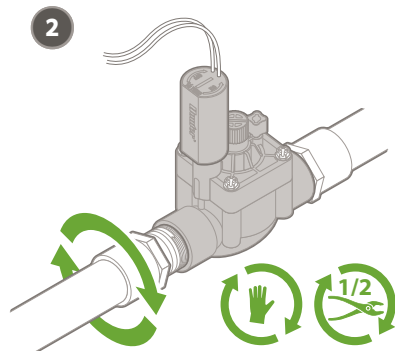
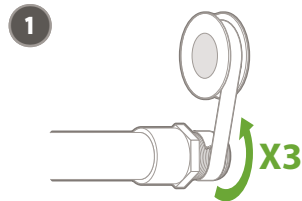
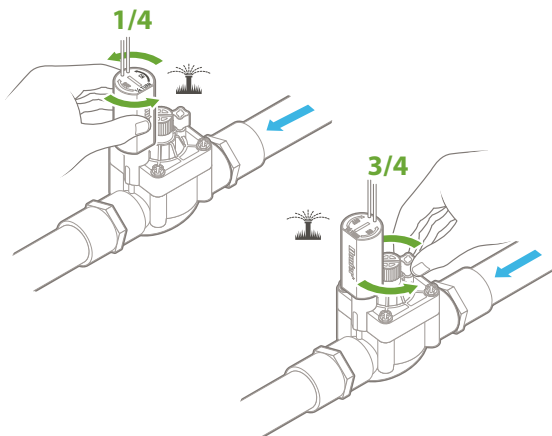
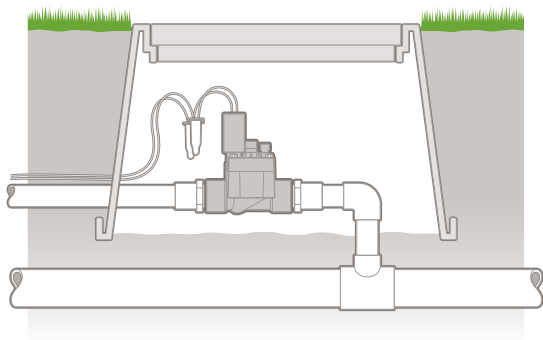

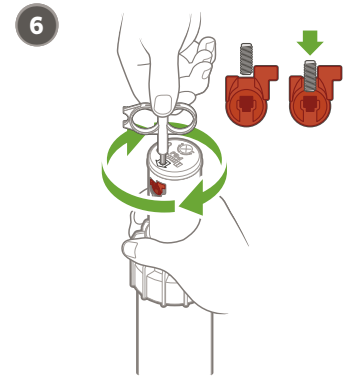
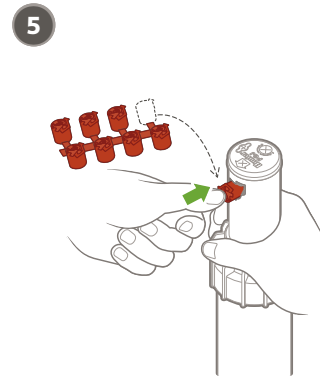
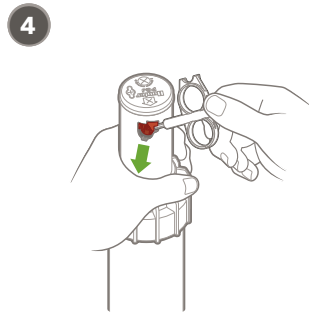
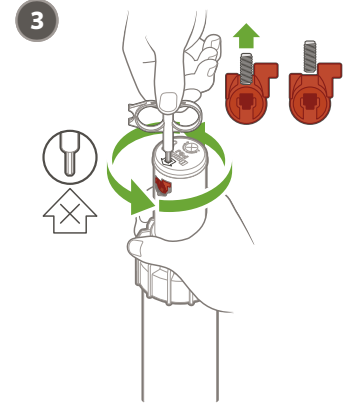
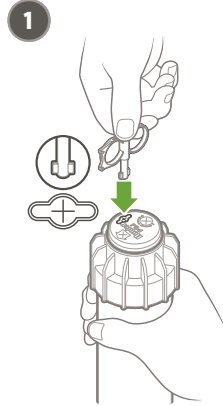

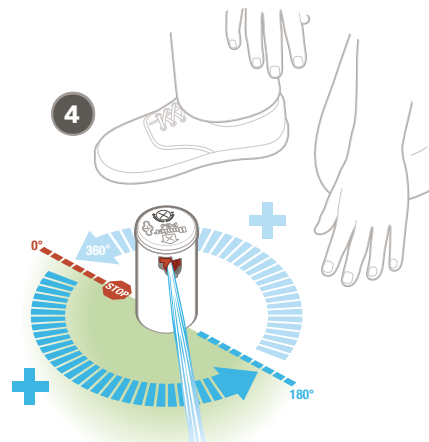
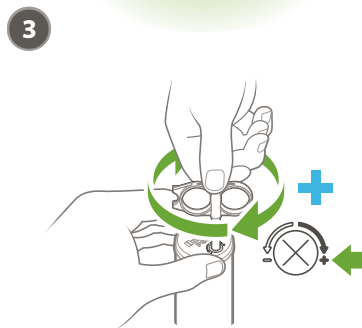
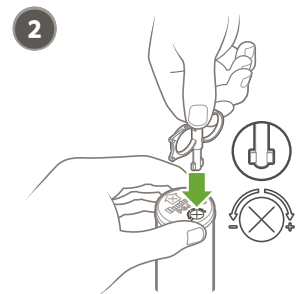
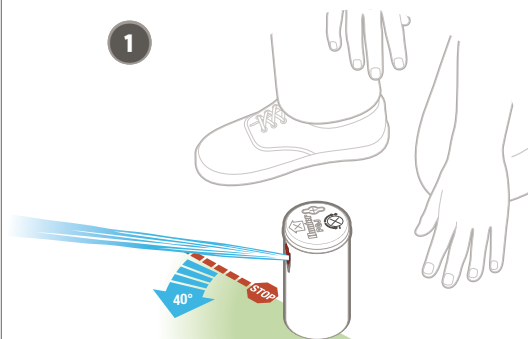
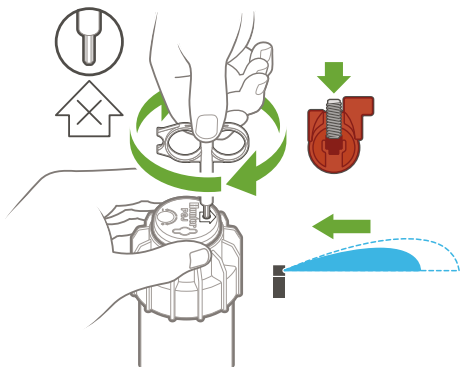
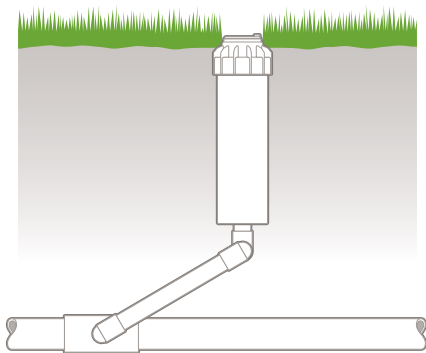



**.75**



1.7-3.8 Bar  
170-380 kPa  
30-50 PSI



2.2-3.4 l/m  
0.6-0.9 GPM



4.6 m-5.2 m  
(15'-17')



**1.0**



1.7-3.8 Bar  
170-380 kPa  
30-50 PSI



3.0-4.2 l/m  
0.9-1.1 GPM



5.5 m-5.8 m  
(18'-19')



**1.5**



1.7-3.8 Bar  
170-380 kPa  
30-50 PSI



4.5-6.7 l/m  
1.3-1.7 GPM

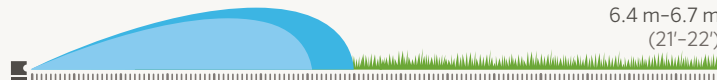

6.4 m-6.7 m  
(21'-22')



**2.0**



1.7-3.8 Bar  
170-380 kPa  
30-50 PSI



5.6-9.3 l/m  
1.7-2.3 GPM



7.3 m-7.6 m  
(24'-25')



**2.5**



1.7-3.8 Bar  
170-380 kPa  
30-50 PSI



7.6-10.9 l/m  
2.2-2.8 GPM

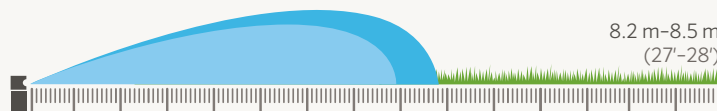

**3.0**



1.7-3.8 Bar  
170-380 kPa  
30-50 PSI



8.5-13.7 l/m  
2.5-3.4 GPM

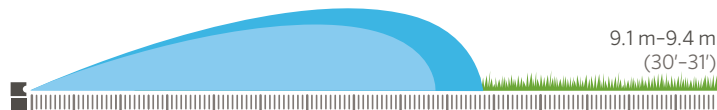

**4.0**



1.7-3.8 Bar  
170-380 kPa  
30-50 PSI



13.3-16.7 l/m  
3.7-4.3 GPM

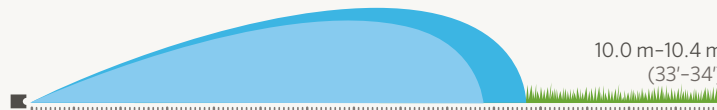

**5.0**



1.7-3.8 Bar  
170-380 kPa  
30-50 PSI



17.0-20.5 l/m  
4.7-5.3 GPM





PGP-ADJ



1

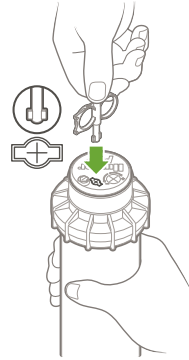

2

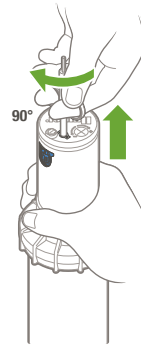

3

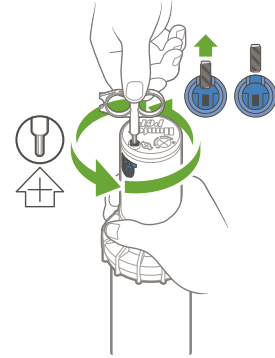

4

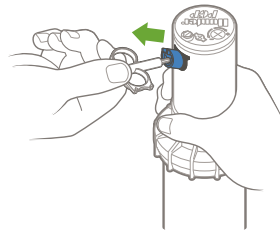

5

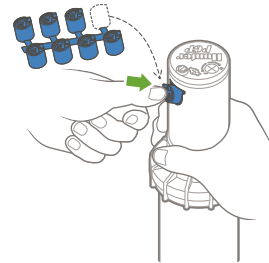

6

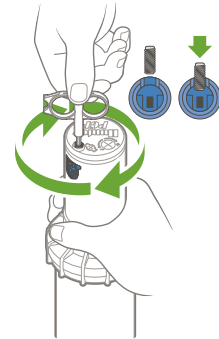

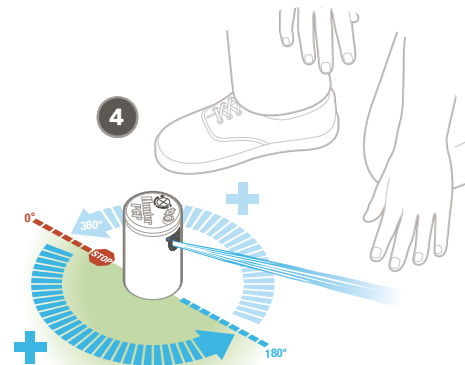
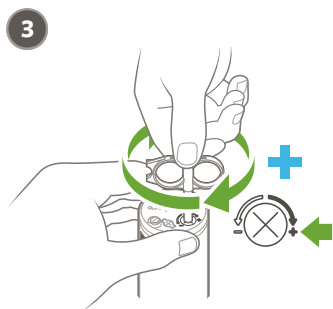
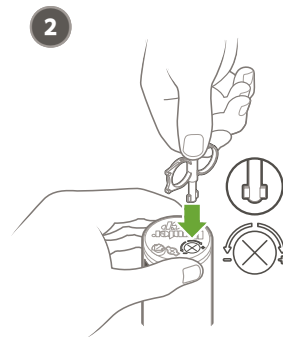
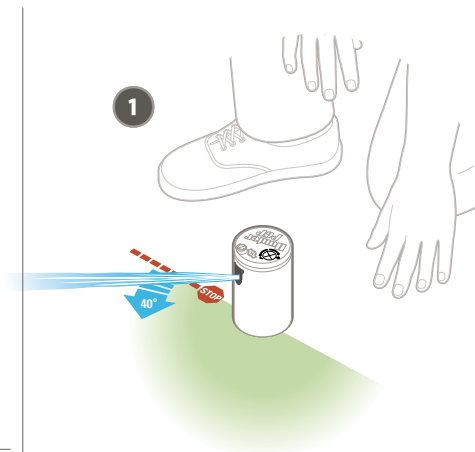
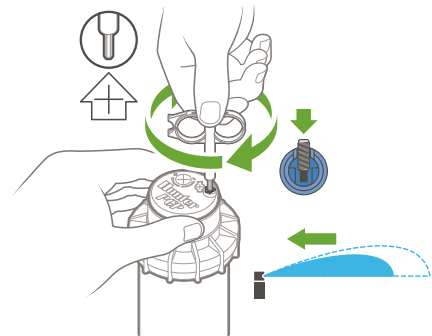
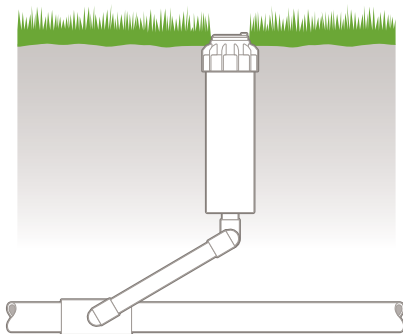



**1.5**



1.7-4.5 Bar  
170-450 kPa  
25-65 PSI



4.5-7.2 l/m  
1.2-1.9 GPM

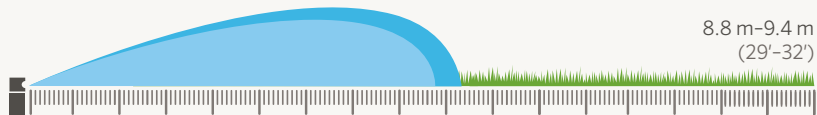

**2.0**



1.7-4.5 Bar  
170-450 kPa  
25-65 PSI



5.4-8.8 l/m  
1.4-2.3 GPM

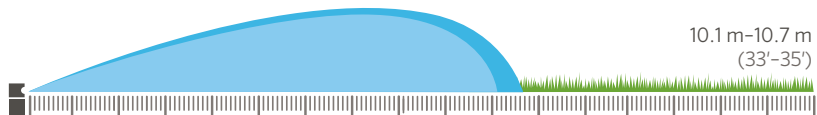

**2.5**



1.7-4.5 Bar  
170-450 kPa  
25-65 PSI



6.6-11.1 l/m  
1.7-2.9 GPM

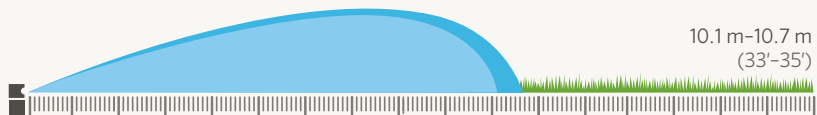

**3.0**



1.7-4.5 Bar  
170-450 kPa  
25-65 PSI



8.4-14.0 l/m  
2.2-3.7 GPM

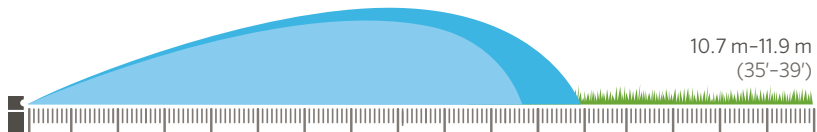





**4.0**



1.7-4.5 Bar  
170-450 kPa  
25-65 PSI



11.3-18.3 l/m  
3.0-4.8 GPM

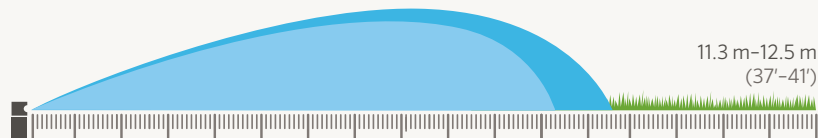

**5.0**



1.7-4.5 Bar  
170-450 kPa  
25-65 PSI



14.0-23.4 l/m  
3.7-6.2 GPM

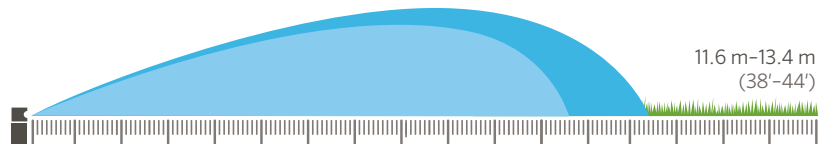

**6.0**



1.7-4.5 Bar  
170-450 kPa  
25-65 PSI



16.8-27.9 l/m  
4.3-7.3 GPM

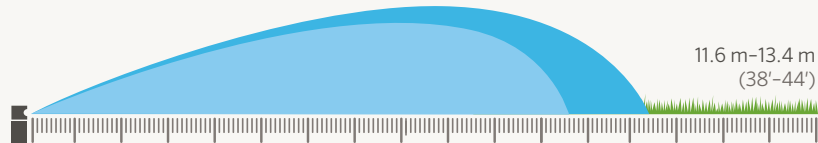

**8.0**



1.7-4.5 Bar  
170-450 kPa  
25-65 PSI



22.5-36.9 l/m  
6.0-9.8 GPM

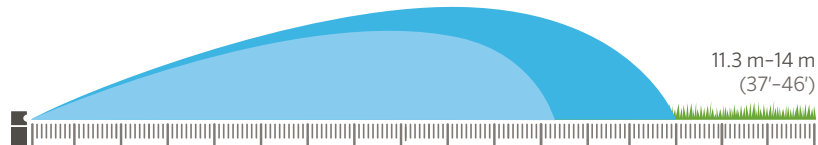

# MP ROTATOR

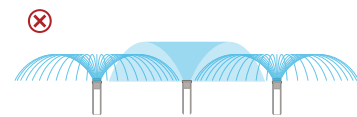
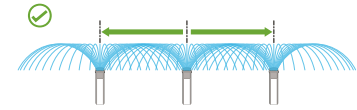
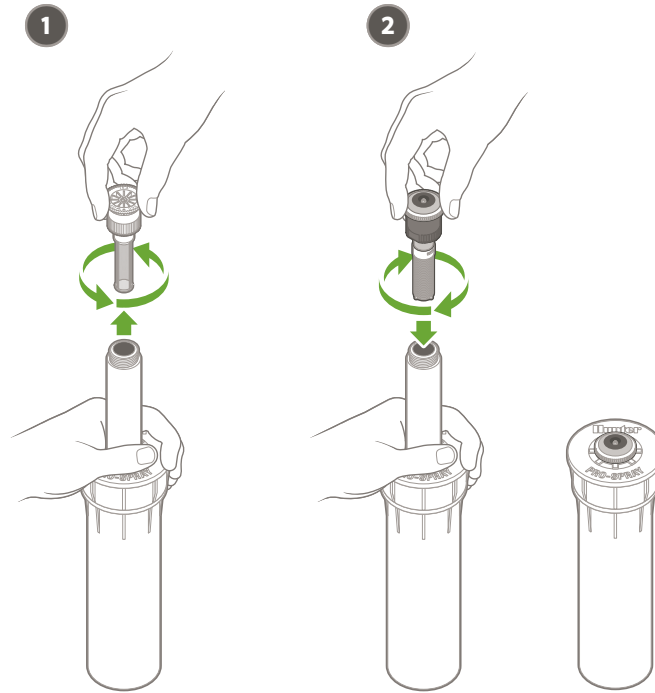

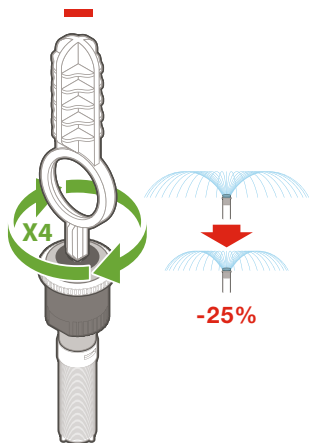
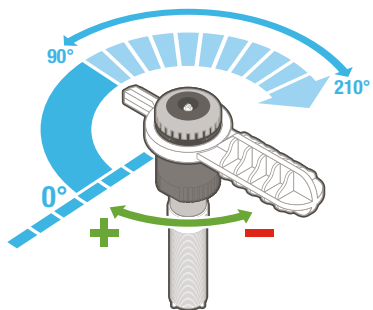

90°-210°



MP100090



210°-270°



MP1000210



360°



MP1000360



**MP1000**



2.4 m-4.6 m  
(8'-15')

MP200090



MP2000210



MP2000360



**MP2000**

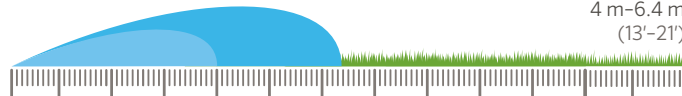

4 m-6.4 m  
(13'-21')

MP300090



MP3000210



MP3000360



**MP3000**

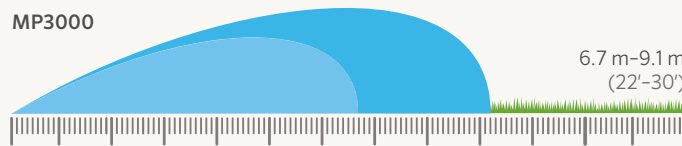

6.7 m-9.1 m  
(22'-30')

MP350090



**MP3500**

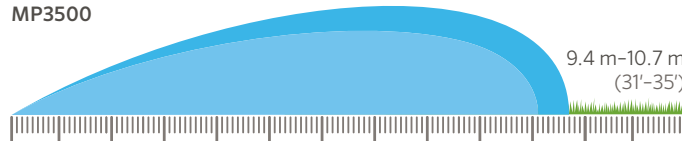

9.4 m-10.7 m  
(31'-35')

# PS ULTRA / PRO-SPRAY



1

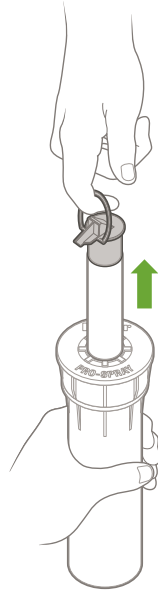
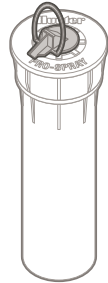

2

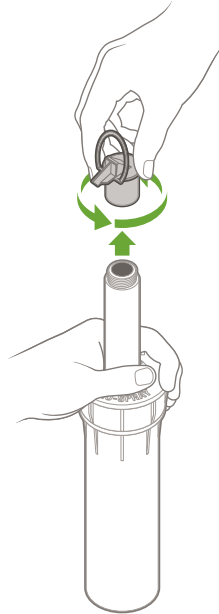

3

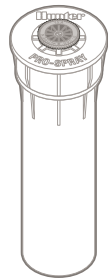
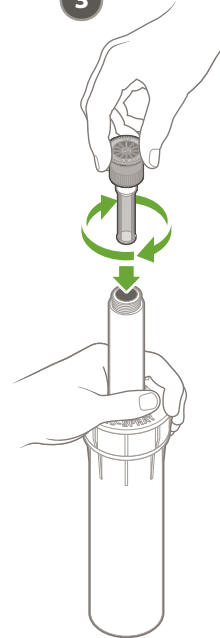

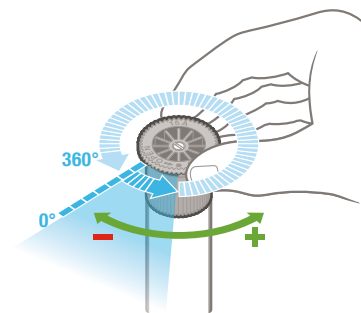
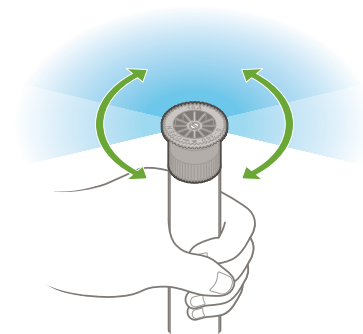
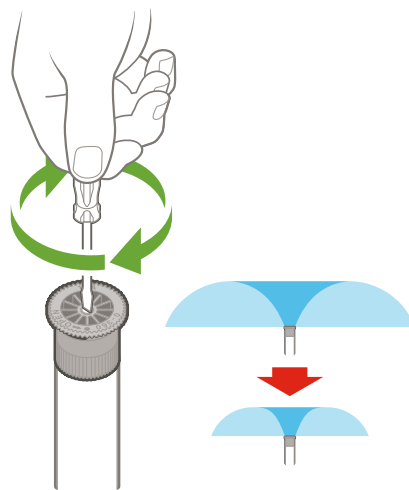
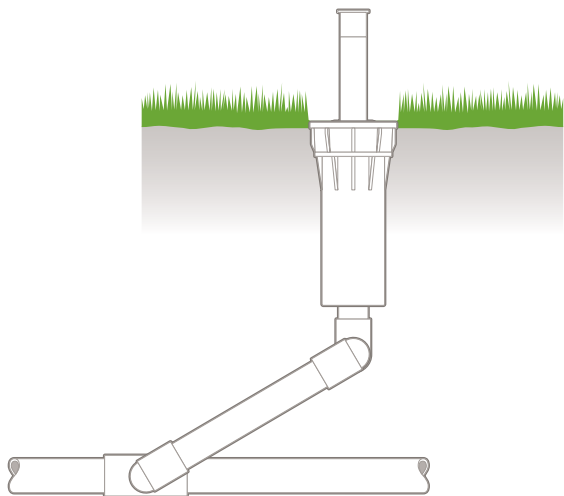



**10A**



1.0–2.5 Bar  
100–250 kPa  
20–40 PSI



0.6–8.3 l/m  
0.2–2.3 GPM



2.1–3.5 m  
(9'–11')



**12A**



1.0–2.5 Bar  
100–250 kPa  
20–40 PSI



0.8–10.7 l/m  
0.3–3.0 GPM



2.7 m–4.2 m  
(11'–13')



**15A**



1.0–2.5 Bar  
100–250 kPa  
20–40 PSI



1.2–15.8 l/m  
0.4–4.7 GPM



3.4 m–5.2 m  
(14'–17')



**17A**



1.0–2.5 Bar  
100–250 kPa  
20–40 PSI



1.5–20.4 l/m  
0.5–5.6 GPM



4.7 m–5.7 m  
(16'–19')

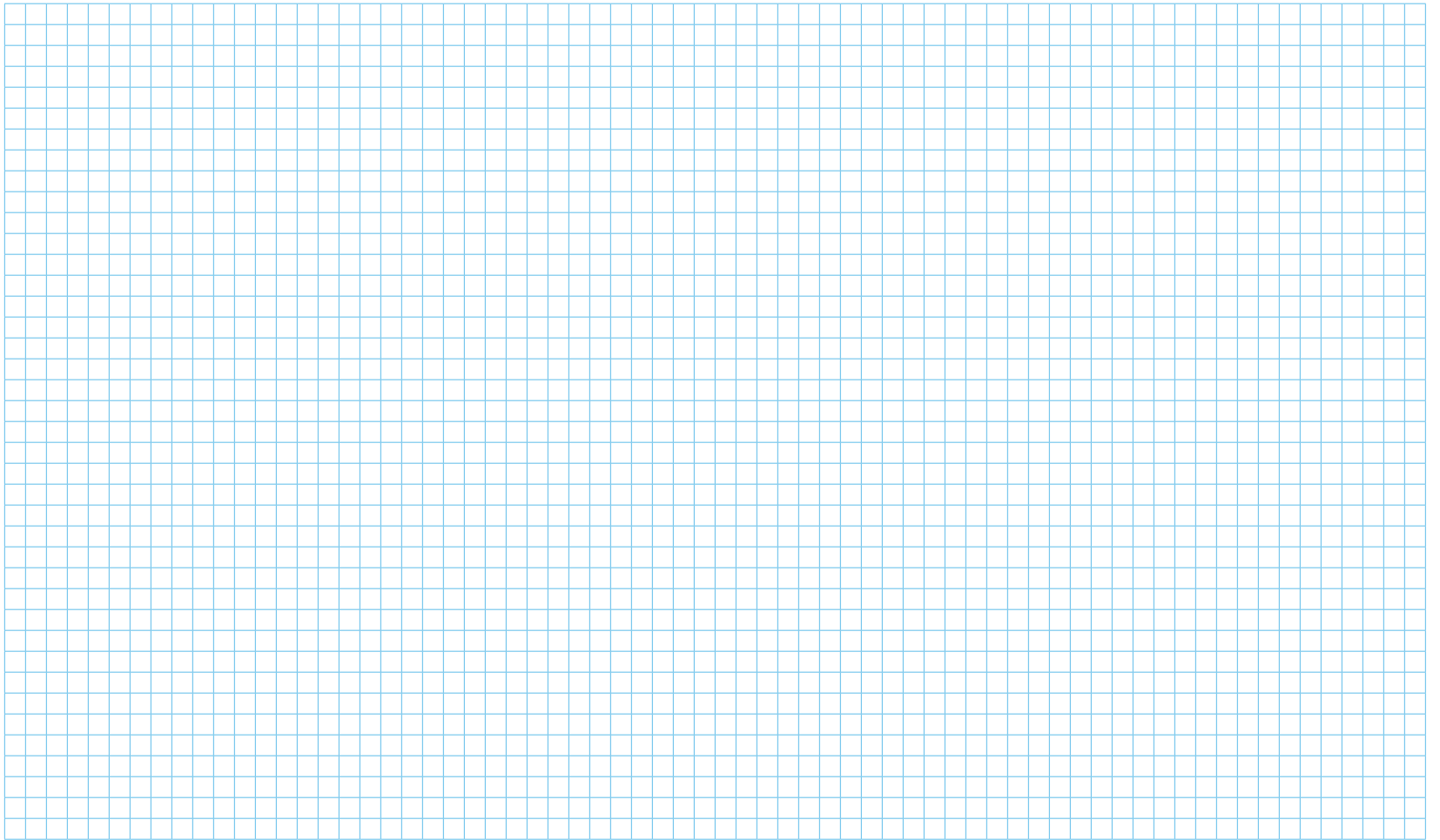

**Hunter**<sup>®</sup>

